

Rz3.2

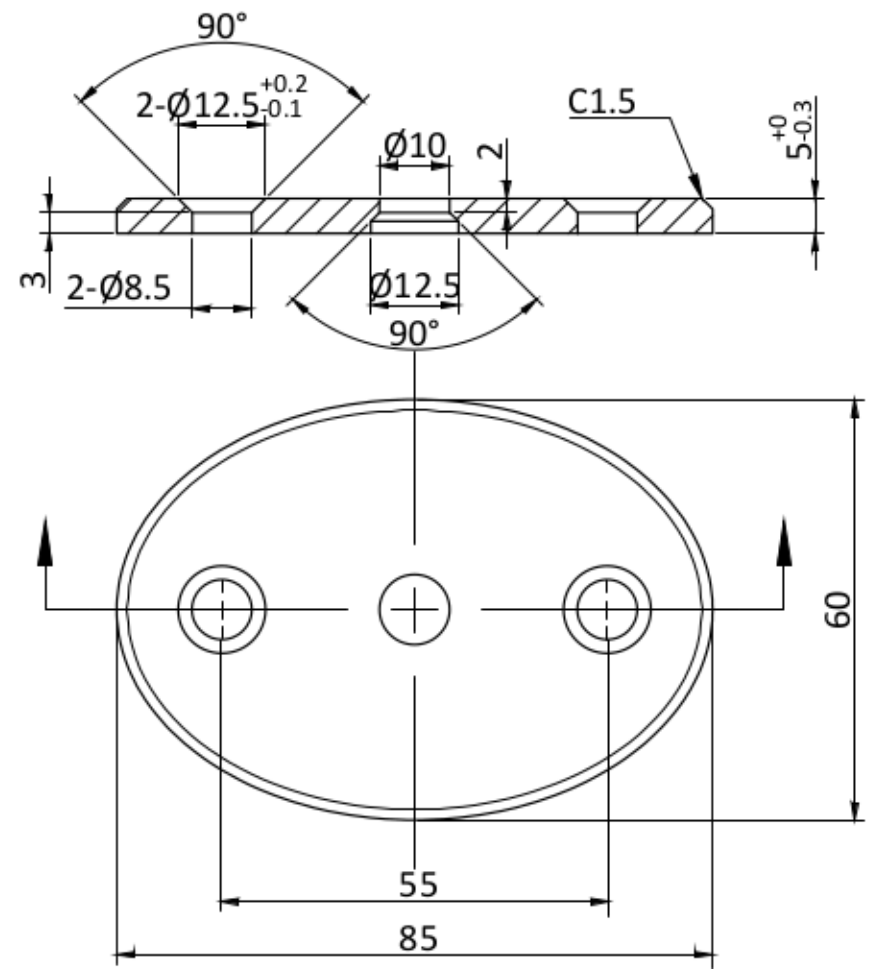

100. 2310		1:1	A0
		SS304	
34085.5.012			